

Stooled Cills

CILL Code	Overall Length (mm)	Price ea.
01-508	693	£27.28
01-511	835	£32.89
01-520	1120	£44.09
01-526	1405	£55.32
01-532	1547 *	£60.90
01-538	1975 *	£77.76
01-540	2015 *	£79.12
01-546	2544 *	£100.18

* Cast in 2 pieces with 10mm joint

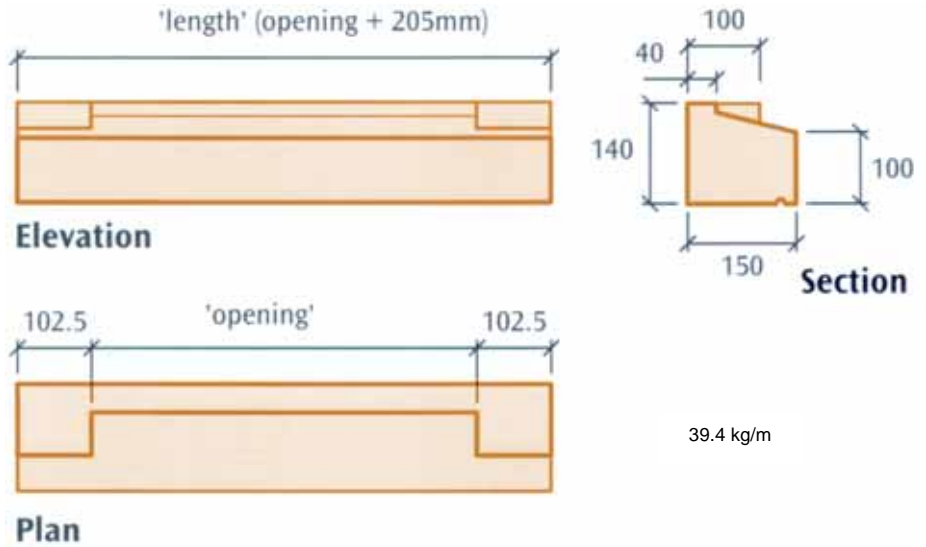

Plain Heads

HEAD Code	Overall Length (mm)	Price ea.
02-508	693	£30.64
02-511	835	£36.92
02-520	1120	£49.52
02-526	1405	£62.10
02-532	1547 *	£68.38
02-538	1975 *	£87.32
02-546	2544 *	£112.48

* Cast in 2 pieces with 10mm joint

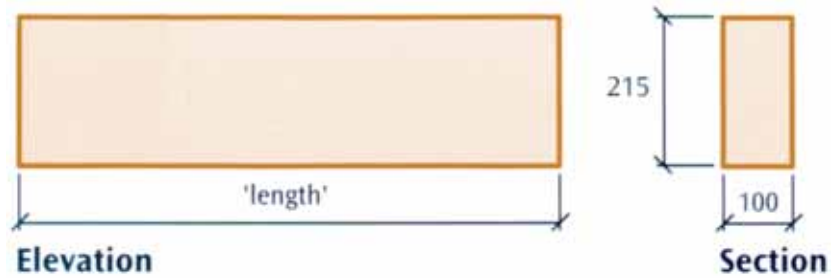

Note: All heads are non-loadbearing and should be supported on an appropriate structural steel lintel.

Clip Keystones

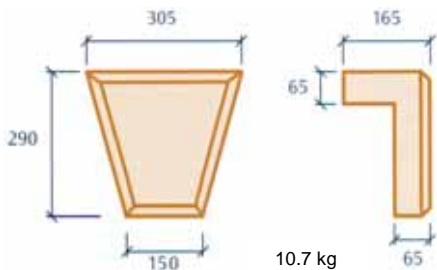

Code	Price ea.
07-365	£28.27

Chamfered Quoins

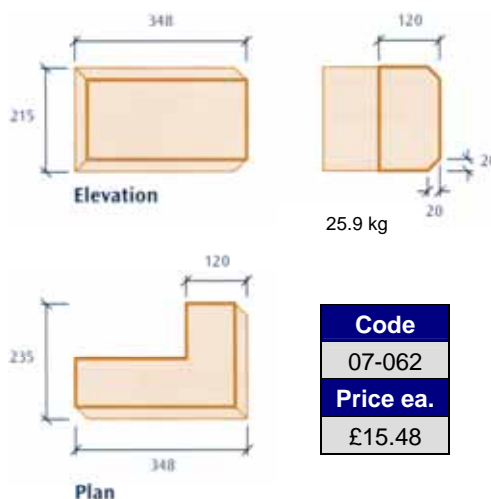

Code
07-062

Price ea.
£15.48

String Course

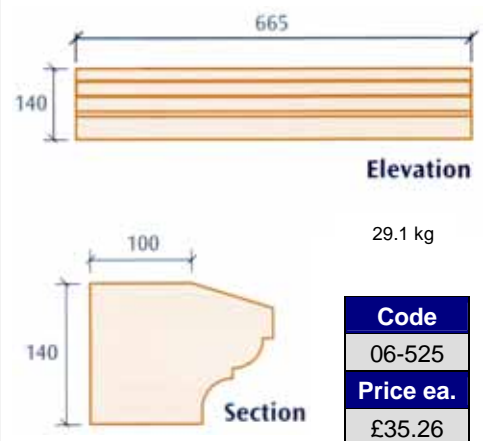

Code
06-525

Price ea.
£35.26

Bullseye Surrounds

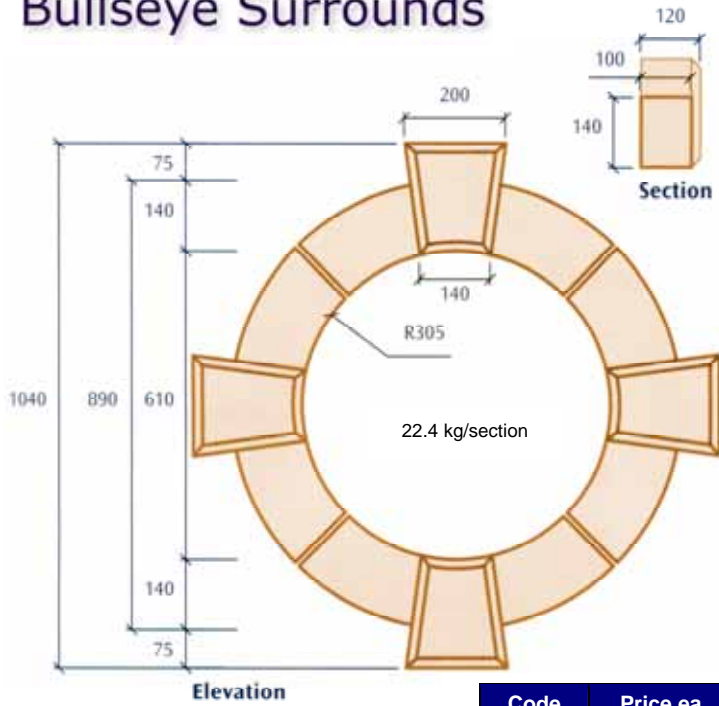

Code	Price ea.
08-065	£192.20

Copings

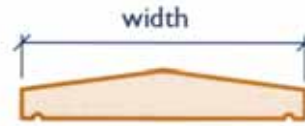

Section

Code	Width	Type	Weight	Price ea.
03-802	180 mm	Straight	7.5 kg	£15.70
03-812	300 mm	Straight	29.5 kg	£29.67
03-818	450 mm	Straight	22.0 kg	£27.34

Copings supplied in 490mm lengths, except 03-812 which is a 990mm length. Flat and once weathered copings also available, please contact Addstone Sales for further details.

Pier Caps

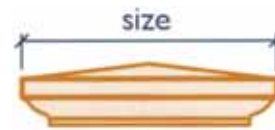

Elevation



Plan

Code	Size	Weight	Price ea.
04-505	420mm x 420	26.3 kg	£54.61
04-507	570mm x 570	42.3 kg	£84.70

Other Pier Caps are also available, please contact Sales.

Balustrade

Many elegant styles available from stock at incredibly low prices.



Contact Addstone Sales for further details and request data sheet **PL02**

Swimming Pool Copings



Vast range available, contact Addstone Sales to request a free copy of data sheet **PL03**

Gable Vents

Code
07-465
Price ea.
£51.83

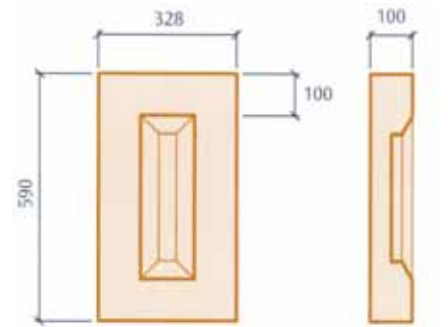

36.6 kg

Corbels

Code
07-565
Price ea.
£37.47

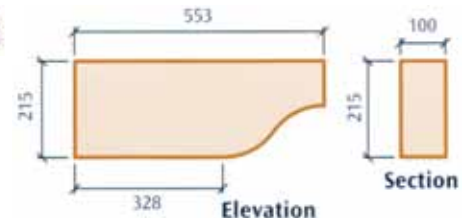

22.8 kg

AddstoneTM
Cast Stone from **STOCK**

Addstone Way • off Anchor Road • Stoke-on-Trent • ST3 5BL
Tel: 01785 878 402 Fax: 01785 819 958
www.addstone.co.uk sales@addstone.co.uk

